

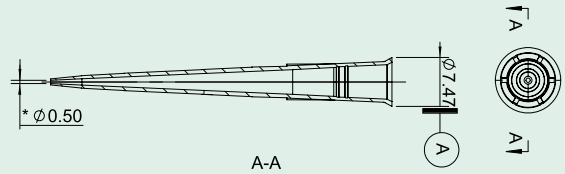

# Blue GEB, Your Better Choice

Tips Compatible for a wide range of pipettors

## Universal Fit Pipette Tips with Aerosol Barrier

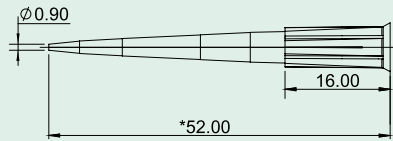

### 200µl, with graduation marks at 10µl, 50µl and 100µl

GEB Cat#	Volume	Type	Packaging Specification	Carton Size L*W*H(mm)	Weight KGs
FT0200-B-N	10-200µl	Natural, Filtered	1000 tips per bag 10 bags per case	480*345*280	5.1
 FT0200-B-N-LB	10-200µl	Natural Filtered, Low Retention	1000 tips per bag 10 bags per case	480*345*280	5.1
FT0200-R-NS	10-200µl	Natural Filtered, Pre-Sterilized	96 tips per rack 10 racks per pack, 5 packs per case	500*265*450	9.5
 FT0200-R-NS-LB	10-200µl	Natural, Filtered Pre-Sterilized, Low Retention	96 tips per rack 10 racks per pack, 5 packs per case	500*265*450	9.5

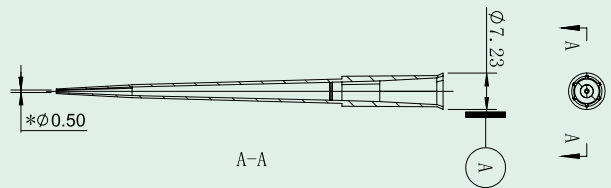
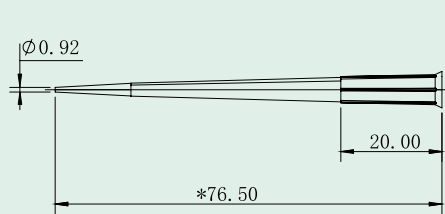

### 200µl Long Version with graduation marks at 10µl, 50µl, 100µl and 200µl

GEB Cat#	Volume	Type	Packaging Specification	Carton Size L*W*H(mm)	Weight KGs
FTL0200-B-N	10-200µl	Natural, Filtered	1000 tips per bag 10 bags per case	480*345*280	5.1
 FTL0200-B-N-LB	10-200µl	Natural Filtered, Low Retention	1000 tips per bag 10 bags per case	480*345*280	5.1
FTL0200-R-NS	10-200µl	Natural Filtered, Pre-Sterilized	96 tips per rack 10 racks per pack, 5 packs per case	500*265*450	9.5
 FTL0200-R-NS-LB	10-200µl	Natural, Filtered Pre-Sterilized, Low Retention	96 tips per rack 10 racks per pack, 5 packs per case	500*265*450	9.5



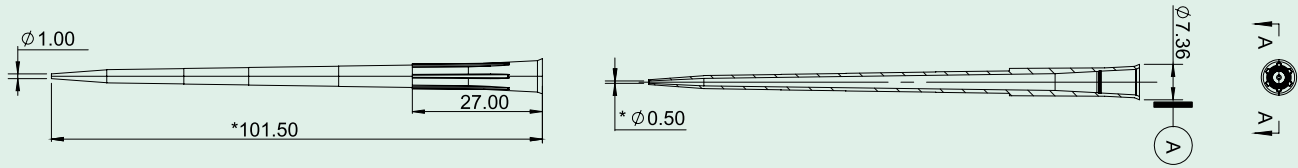

Tips Compatible for a wide range of pipettors

## Universal Fit Pipette Tips with Aerosol Barrier



### 300µl Long Version with graduation marks at 10µl, 50µl, 100µl, 200µl and 300µl

GEB Cat#	Volume	Type	Packaging Specification	Carton Size L*W*H(mm)	Weight KGs
FTXL0300-B-N	10-300µl	Natural, Filtered	1000 tips per bag 10 bags per case	595*325*310	8.82
 FTXL0300-B-N-LB	10-300µl	Natural Filtered, Low Retention	1000 tips per bag 10 bags per case	595*325*310	8.82
FTXL0300-R-NS	10-300µl	Natural Filtered, Pre-Sterilized	96 tips per rack 10 racks per pack, 5 packs per case	495*285*650	13.5
 FTXL0300-R-NS-LB	10-300µl	Natural, Filtered Pre-Sterilized, Low Retention	96 tips per rack 10 racks per pack, 5 packs per case	495*285*650	13.5

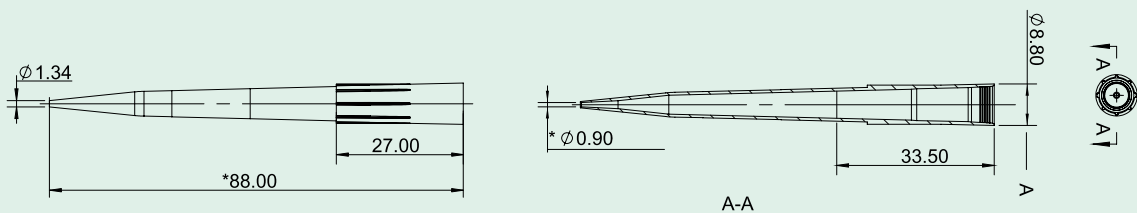

### 500µl, with graduation marks at 100µl, 200µl and 500µl

GEB Cat#	Volume	Type	Packaging Specification	Carton Size L*W*H(mm)	Weight KGs
FT0500-B-N	100-500µl	Natural, Filtered	1000 tips per bag 5 bags per case	690*235*330	5.9
 FT0500-B-N-LB	100-500µl	Natural Filtered, Low Retention	1000 tips per bag 5 bags per case	690*235*330	5.9
FT0500-R-NS	100-500µl	Natural Filtered, Pre-Sterilized	96 tips per rack 10 racks per pack, 5 packs per case	595*285*475	13.5
 FT0500-R-NS-LB	100-500µl	Natural, Filtered Pre-Sterilized, Low Retention	96 tips per rack 10 racks per pack, 5 packs per case	595*285*475	13.5



# Blue GEB, Your Better Choice

Tips Compatible for a wide range of pipettors

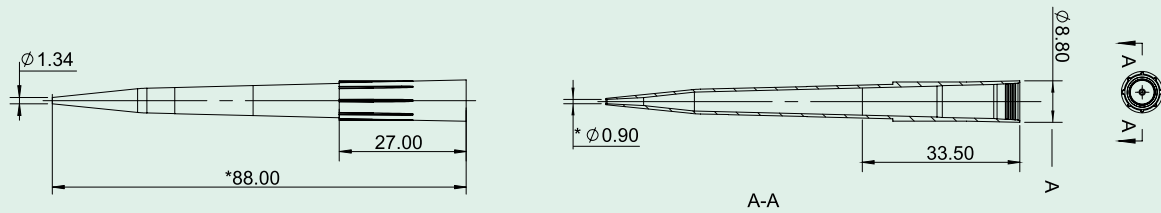
## Universal Fit Pipette Tips with Aerosol Barrier



### 1000µl, with graduation marks at 50µl, 100µl, 200µl and 500µl

GEB Cat#	Volume	Type	Packaging Specification	Carton Size L*W*H(mm)	Weight KGs
FT1000-B-N	100-1000µl	Natural, Filtered	1000 tips per bag 5bags per case	690*235*330	5.8
 FT1000-B-N-LB	100-1000µl	Natural Filtered, Low Retention	1000 tips per bag 5 bags per case	690*235*330	5.8
FT1000-R-NS	100-1000µl	Natural Filtered, Pre-Sterilized	96 tips per rack 10racks per pack, 5 packs per case	595*285*475	15.0
 FT1000-R-NS-LB	100-1000µl	Natural, Filtered Pre-Sterilized, Low Retention	96 tips per rack 10racks per pack, 5 packs per case	595*285*475	15.0

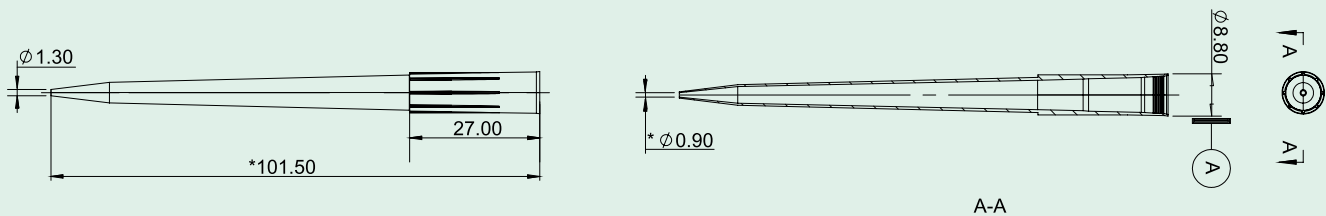

### 1000µl Long Version with graduation marks at 50µl, 100µl, 200µl and 500µl

GEB Cat#	Volume	Type	Packaging Specification	Carton Size L*W*H(mm)	Weight KGs
FTL1000-B-N	100-1000µl	Natural, Filtered	1000 tips per bag 5bags per case	690*235*330	5.8
 FTL1000-B-N-LB	100-1000µl	Natural Filtered, Low Retention	1000 tips per bag 5 bags per case	690*235*330	5.8
FTL1000-R-NS	100-1000µl	Natural Filtered, Pre-Sterilized	96 tips per rack 10racks per pack, 5 packs per case	475*285*595	13.5
 FTL1000-R-NS-LB	100-1000µl	Natural, Filtered Pre-Sterilized, Low Retention	96 tips per rack 10racks per pack, 5 packs per case	475*285*595	13.5



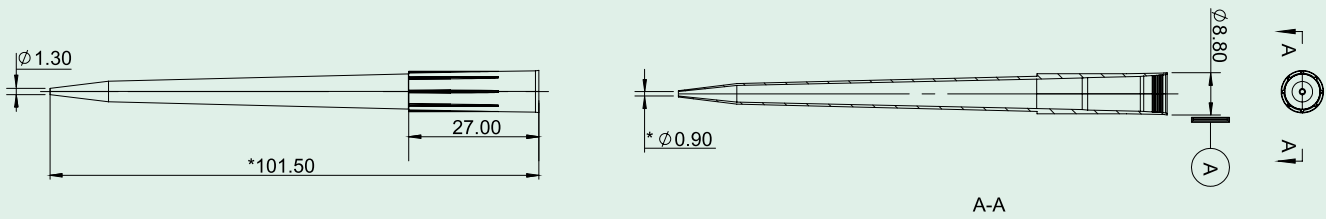

Tips Compatible for a wide range of pipettors

## Universal Fit Pipette Tips with Aerosol Barrier



### 1250µl Long Version with graduation marks at 50µl, 100µl, 200µl and 500µl

GEB Cat#	Volume	Type	Packaging Specification	Carton Size L*W*H(mm)	Weight KGs
FTL1250-B-N	100-1250µl	Natural, Filtered	1000 tips per bag 5 bags per case	690*235*330	5.8
 FTL1250-B-N-LB	100-1250µl	Natural Filtered, Low Retention	1000 tips per bag 5 bags per case	690*235*330	5.8
FTL1250-R-NS	100-1250µl	Natural Filtered, Pre-Sterilized	96 tips per rack 10 racks per pack, 5 packs per case	650*285*495	13.5
 FTL1250-R-NS-LB	100-1250µl	Natural, Filtered Pre-Sterilized, Low Retention	96 tips per rack 10 racks per pack, 5 packs per case	650*285*495	13.5



# Blue GEB, Your Better Choice

## Tip Series - Compatibility

BRAND OF PIPETTOR	VOLUME RANGE	PT0010	PT0200	PT0300	PT1000	PTL1250	FT0010	FT0020	FT0100	FT0200	FT0500	FT1000	FTL1250
<b>BIOHIT</b>													
PROLINE-Single channel	0.2-10µl	✓					✓	✓					
	5-100µl		✓						✓				
	10-250µl		✓	✓					✓	✓			
	10-500µl				✓						✓		
	50-1000µl				✓	✓					✓	✓	✓
PROLINE-Multi channel	0.2-10µl	✓						✓					
	5-100µl		✓						✓				
	25-250µl		✓	✓					✓	✓			
E-LINE-Single channel	0.2-10µl	✓					✓						
	5-120µl		✓						✓	✓			
	10-300µl		✓	✓				✓	✓	✓			
	50-1000µl		✓		✓	✓					✓	✓	✓
E-LINE-Multi channel	0.2-10µl	✓					✓						
	5-120µl		✓						✓				
	10-300µl		✓	✓					✓	✓			
M-LINE-Single channel	0.5-10µl	✓					✓						
	2-20µl		✓				✓						
	10-100µl		✓						✓				
	20-200µl		✓	✓					✓	✓			
	100-1000µl				✓	✓					✓	✓	✓
M-LINE-Multi channel	0.5-10µl	✓					✓						
	5-100µl		✓					✓	✓				
	30-300µl		✓	✓					✓	✓			
<b>MATRIX</b>													
Impact/Impact2-Single channel	2-125 µl		✓							✓			
	5-250µl									✓			
	15-1250µl												
Impact/Impact2-Multi channel	2-125 µl		✓				✓						
	5-250µl			✓						✓			
	15-1250µl												

## Tip Series - Compatibility

BRAND OF PIPETTOR	VOLUME RANGE	PT0010	PT0200	PT0300	PTI000	PTL1250	FT0010	FT0020	FT0100	FT0200	FT0500	FTI000	FTL1250
<b>BRANDTECH</b>													
TRANSFERPETTE-Single channel	0.1-1µl	✓					✓	✓					
	0.5-10µl	✓					✓	✓					
	2-20µl		✓					✓					
	5-50µl		✓	✓				✓	✓				
	10-100µl		✓						✓				
	20-200µl		✓	✓					✓	✓			
	25-250µl		✓	✓					✓	✓			
	100-1000µl					✓	✓					✓	✓
TRANSFERPETTE-Multi channel	0.5-10µl	✓					✓	✓					
	2-20µl	✓	✓				✓	✓					
	2.5-25µl		✓					✓					
	5-50µl		✓					✓					
	10-100µl		✓					✓					
	20-200µl		✓	✓					✓	✓			
	30-300µl		✓	✓					✓	✓			✓
<b>CAPP AERO</b>													
Pipettor-Single channel	0.2-10µl	✓					✓	✓					
	0.5-10µl	✓					✓	✓					
	2-20µl		✓					✓	✓				
	10-100µl		✓						✓				
	25-200µl		✓	✓						✓			
	50-300µl		✓	✓					✓	✓			
	100-1000µl					✓	✓						✓
Pipettor-Multi channel	0.2-10µl	✓					✓	✓					
	0.5-10µl	✓					✓	✓					
	2-20µl		✓					✓	✓				
	10-100µl		✓	✓					✓	✓			
	25-200µl		✓	✓					✓	✓			
	50-300µl		✓	✓					✓	✓			
	100-1000µl					✓	✓					✓	✓

# Blue GEB, Your Better Choice

## Tip Series - Compatibility

BRAND OF PIPETTOR	VOLUME RANGE	PT0010	PT0200	PT0300	PT1000	PTL1250	FT0010	FT0020	FT0100	FT0200	FT0500	FT1000	FTL1250
<b>EPPENDORF</b>													
ELECTRONIC	0.5-10µl	✓					✓	✓					
	5-100µl		✓						✓	✓			
	20-200µl		✓	✓					✓	✓			
	50-1000µl				✓	✓					✓	✓	
REFERENCE	0.1-1µl	✓					✓						
	2-20 µl		✓										
	10-100µl		✓						✓	✓			
	20-200µl		✓	✓					✓	✓			
	100-1000µl				✓	✓					✓	✓	✓
RESEARCH-Single channel	0.1-2.5µl	✓					✓						
	0.5-10µl	✓					✓						
	2-20 µl		✓										
	10-100µl		✓				✓						
	20-200µl		✓	✓									
	100-1000µl				✓	✓						✓	✓
RESEARCH-Multi channel		✓					✓						
	5-100µl		✓						✓				
	50-100µl		✓						✓	✓			
	20-300µl		✓	✓						✓			
	30-300µl		✓	✓									
50-1200µl				✓	✓								
<b>THERMOLABSYSTEMS</b>													
FINNPIPETTE-Single channel	0.2-10µl	✓					✓						
	0.5-10µl	✓					✓						
	5-40µl		✓						✓				
	40-200µl		✓	✓						✓			
	100-1000µl				✓	✓					✓	✓	✓
	200-1000µl				✓	✓					✓	✓	✓
FINNPIPETTE-Multi channel	5-50µl		✓						✓				
	50-300µl		✓	✓					✓	✓			

## Tip Series - Compatibility

BRAND OF PIPETTOR	VOLUME RANGE	PT0010	PT0200	PT0300	PT1000	PTL1250	FT0010	FT0020	FT0100	FT0200	FT0500	FT1000	FTL1250
<b>GILSON</b>													
PIPETMAN-Single channel	0.1-2µl	✓					✓						
	0.2-10µl	✓					✓						
	2-20µl		✓										
	10-100µl		✓	✓				✓	✓	✓			
	20-200µl		✓	✓				✓	✓	✓			
	100-1000µl					✓	✓					✓	✓
PIPETMAN-Multi channel	20-200µl		✓	✓						✓	✓	✓	
<b>NICHIRYO/OXFORD</b>													
Benchmate	0.5-10µl	✓					✓						
	2-20µl		✓					✓					
	10-50µl		✓					✓	✓				
	10-100µl												
	20-200µl												
	100-1000µl												
<b>RAININ</b>													
EDP3-Single-channel	0.5-10µl	✓					✓						
	2.5-25µl		✓						✓				
	10-100µl		✓	✓					✓	✓			
	25-250µl		✓	✓					✓	✓			
	100-1000µl					✓	✓					✓	✓
EDP3-Multi-channel	0.5-10µl	✓					✓						
	10-250µl		✓	✓				✓	✓	✓			
LATCH MODE	0.1-2µl	✓					✓						
	0.2-10µl	✓											
	2-20µl		✓					✓					
	10-100µl		✓	✓				✓	✓	✓			
	20-200µl		✓	✓				✓	✓	✓			
	100-1000µl					✓	✓					✓	✓



# Blue GEB, Your Better Choice

## Tip Series - Compatibility

BRAND OF PIPETTOR	VOLUME RANGE	PT0010	PT0200	PT0300	PTI000	PTL1250	FT0010	FT0020	FT0100	FT0200	FT0500	FTI000	FTL1250
<b>SOCORE</b>													
CALIBRA/ACURA-Single channel	0.1-1µl	✓					✓						
	0.5-10µl	✓					✓						
	2-20µl		✓					✓					
	5-50µl		✓						✓				
	10-100µl		✓					✓	✓				
	20-200µl		✓	✓				✓	✓	✓			
	25-250µl		✓	✓						✓			
	100-1000µl				✓	✓					✓	✓	✓
CALIBRA/ACURA-Multi channel	2.5-25µl		✓						✓				
	5-50µl		✓					✓					
	10-100µl		✓	✓				✓	✓				
	20-200µl		✓	✓				✓	✓	✓			
	30-300µl		✓	✓					✓	✓			
<b>VWR</b>													
SIGNATURE-Single channel	0.1-2µl	✓					✓						
	0.5-10µl	✓					✓						
	2-20µl		✓					✓	✓				
	5-100µl		✓						✓				
	10-100µl		✓	✓				✓	✓	✓			
	20-200µl		✓	✓				✓	✓	✓			
	50-250µl		✓	✓					✓				
	100-1000µl				✓	✓					✓	✓	✓
SIGNATURE-Multi channel	1-10µl	✓					✓						
	5-50µl		✓					✓	✓				
	20-200µl		✓	✓				✓	✓	✓			
	50-300µl		✓	✓					✓	✓			

# Serological Pipette



Clear and bidirectional graduations on the pipette, negative graduation.  
Allows additional working volume.  
Our innovation guarantees your pipetting with improved accuracy and flexibility.



Color-coded packaging for sorting and selecting  
Filter plug prevents overflow.  
Certified: DNase-Free, RNase-Free, Endotoxin-Safe.

GEB produces pipette tips with exclusive techniques of TWC Thin Wall Crown and R&R Low Retention so that the cooperation between pipettor and tip is optimized.

The liquid handling will be more accurate and flexible with GEB pipette tips.



# Blue GEB, Your Better Choice



GEB Cat#	Type	Volume	Color code	Packaging	Packaging Specification
SEP01ML-B		1 ml	Yellow	Bulk	50pcs per bag, 10 bags per case
SEP01ML-B-S	Sterilized	1 ml	Yellow	Bulk	50pcs per bag, 10 bags per case
SEP02ML-B		2 ml	Green	Bulk	50pcs per bag, 10 bags per case
SEP02ML-B-S	Sterilized	2 ml	Green	Bulk	50pcs per bag, 10 bags per case
SEP05ML-B		5 ml	Blue	Bulk	50pcs per bag, 10 bags per case
SEP05ML-B-S	Sterilized	5 ml	Blue	Bulk	50pcs per bag, 10 bags per case
SEP10ML-B		10 ml	Orange	Bulk	50pcs per bag, 8 bags per case
SEP10ML-B-S	Sterilized	10 ml	Orange	Bulk	50pcs per bag, 8 bags per case
SEP25ML-B		25 ml	Red	Bulk	25pcs per bag, 8 bags per case
SEP25ML-B-S	Sterilized	25 ml	Red	Bulk	25pcs per bag, 8 bags per case
SEP50ML-B		50 ml	Purple	Bulk	25pcs per bag, 4 bags per case
SEP50ML-B-S	Sterilized	50 ml	Purple	Bulk	25pcs per bag, 4 bags per case

# Tubes

## Optimum Sample Handling

Optimum safelocker design, high quality virgin resin, R&R GEB retentionless recovery technique, etc., will help you to optimize your sample handling.

-----  
Proteomics.Drug R&D.Genomics.HTS



GEB **DUAL SNAPLOCK** system provides you double cap lock for micro centrifuge tubes with a safer leakproofness to protect your reaction systems or biological solutions.

**DUAL SNAPLOCK** system also creates a "half lock" status which provides a flexible position during your multiple reagents processing steps.

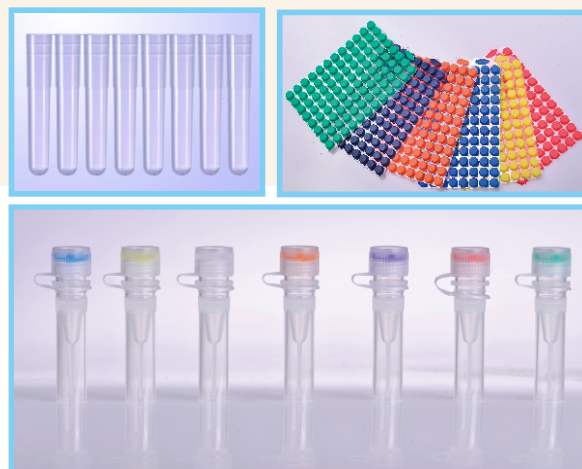

Unique O-ring integrated design ensures better protection for your reagents

### Features:

- Glass-like transparent tubes are also available in seven additional colours.
- Snap-lock tubes are guaranteed to stay closed, even during boiling or autoclaving.
- Withstand up to 20,000 RCF.
- Snap-lock cap ensures efficient seal, yet is still easy to 'flip' open.
- Thin membrane in the caps centre allows easy piercing by syringe needle.
- Certified RNase, DNase, protease and endotoxin-free for total sample integrity.
- Apparent scale identification to facilitate control of liquid volume.

# Blue GEB, Your Better Choice

## GEB Microcentrifuge Tubes



### 0.6ml



GEB Cat#	Volume	Type	Packaging Specification	Carton Size L*W*H(mm)	Weight KGs
CT0050-B-N	0.6ml	Natural	1000 tubes per bag, 10 bags per case	730*250*345	12.5
CT0050-B-N-LB	0.6ml	Natural Low Retention	1000 tubes per bag, 10 bags per case	730*250*345	12.5

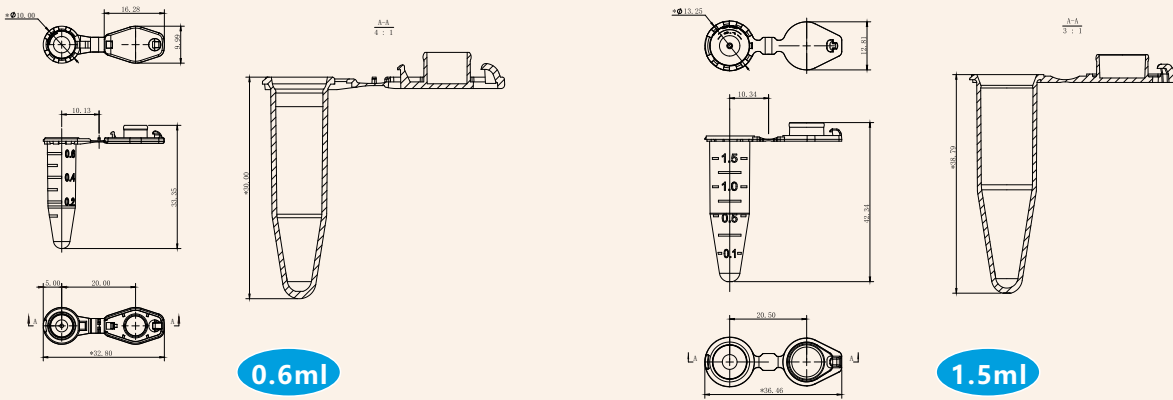

### 1.5ml



GEB Cat#	Volume	Type	Packaging Specification	Carton Size L*W*H(mm)	Weight KGs
CT0150-B-N	1.5 ml	Natural	500 tubes per bag, 10 bags per case	730*250*345	8.5
CT0150-B-N-LB	1.5 ml	Natural Low Retention	500 tubes per bag, 10 bags per case	730*250*345	8.5
CT0150-B-B	1.5 ml	Blue	500 tubes per bag, 10 bags per case	730*250*345	8.5
CT0150-B-B-LB	1.5 ml	Blue Low Retention	500 tubes per bag, 10 bags per case	730*250*345	8.5
CT0150-B-G	1.5 ml	Green	500 tubes per bag, 10 bags per case	730*250*345	8.5
CT0150-B-G-LB	1.5 ml	Green Low Retention	500 tubes per bag, 10 bags per case	730*250*345	8.5
CT0150-B-O	1.5 ml	Orange	500 tubes per bag, 10 bags per case	730*250*345	8.5
CT0150-B-O-LB	1.5 ml	Orange Low Retention	500 tubes per bag, 10 bags per case	730*250*345	8.5

## GEB Microcentrifuge Tubes

### 1.5ml

	GEB Cat#	Volume	Type	Packaging Specification	Carton Size L*W*H(mm)	Weight KGs
	CT0150-B-R	1.5 ml	Red	500 tubes per bag, 10 bags per case	730*250*345	8.5
	CT0150-B-R-LB	1.5 ml	Red Low Retention	500 tubes per bag, 10 bags per case	730*250*345	8.5
	CT0150-B-V	1.5 ml	Violet	500 tubes per bag, 10 bags per case	730*250*345	8.5
	CT0150-B-V-LB	1.5 ml	Violet Low Retention	500 tubes per bag, 10 bags per case	730*250*345	8.5
	CT0150-B-A	1.5 ml	Amber	500 tubes per bag, 10 bags per case	730*250*345	8.5
	CT0150-B-A-LB	1.5 ml	Amber Low Retention	500 tubes per bag, 10 bags per case	730*250*345	8.5
	CT0150-B-Y	1.5 ml	Yellow	500 tubes per bag, 10 bags per case	730*250*345	8.5
	CT0150-B-Y-LB	1.5 ml	Yellow Low Retention	500 tubes per bag, 10 bags per case	730*250*345	8.5

### 2.0ml

	GEB Cat#	Volume	Type	Packaging Specification	Carton Size L*W*H(mm)	Weight KGs
	CT0200-B-N	2.0ml	Natural	500 tubes per bag, 10 bags per case	730*250*345	11.2
	CT0200-B-N-LB	2.0ml	Natural Low Retention	500 tubes per bag, 10 bags per case	730*250*345	11.2

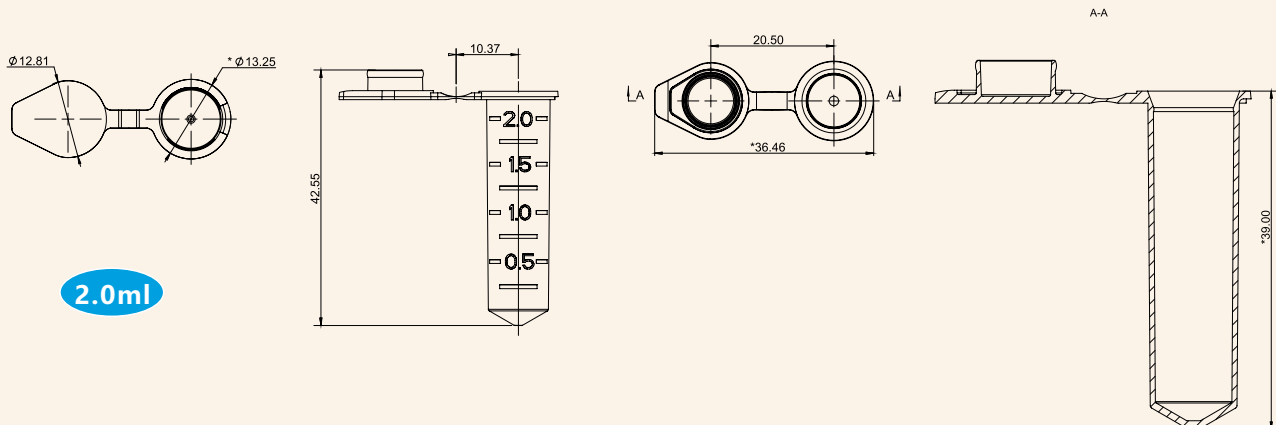

# Blue GEB, Your Better Choice

## GEB Microcentrifuge Tubes



### 5.0ml



GEB Cat#	Volume	Type	Color	Packaging Specification
CT005M-L-B-N	5ml	No Graduated	Natural	300 tubes per bag, 10 bags per case
 CT005M-L-G-B-N	5ml	Graduated	Natural	300 tubes per bag, 10 bags per case

### 7.0ml



GEB Cat#	Volume	Type	Color	Packaging Specification
CT007M-R-B-N	7ml	Round Bottom	Natural	200 tubes per bag, 10 bags per case

### 10ml



GEB Cat#	Volume	Type	Color	Packaging Specification
CT010M-R-B-N	10ml	Round Bottom	Natural	200 tubes per bag, 10 bags per case

### 15ml

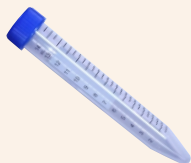

GEB Cat#	Volume	Type	Color	Packaging Specification
CT015M-C-B-N	15ml	Conical Bottom	Natural	100 tubes per bag, 12 bags per case

### 50ml

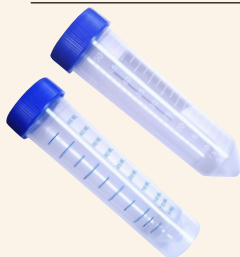

GEB Cat#	Volume	Type	Color	Packaging Specification
CT050M-SS-C-B-N	50ml	Conical Bottom Self-standing	Natural	40 tubes per bag, 10 bags per case
 CT050M-C-B-N	50ml	Conical Bottom	Natural	40 tubes per bag, 10 bags per case

### 50ml

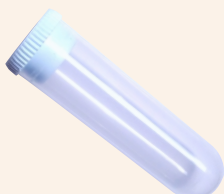

GEB Cat#	Volume	Type	Color	Packaging Specification
CT050M-R-B-N	50ml	Round Bottom	Natural	50 tubes per bag, 10 bags per case

## Screw Cap Tubes With Caps



**Packaging Specification:**  
500 tubes per bag, 8 bags per case

**Carton Size(L\*W\*H):**  
690\*235\*330mm

**Weight:**  
15.6kg

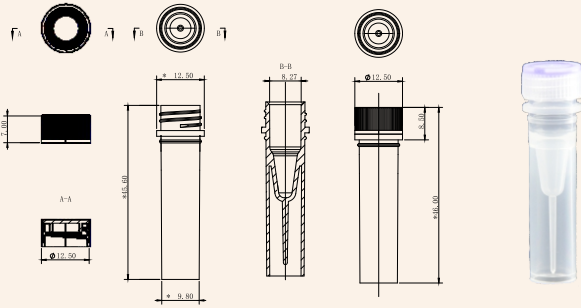
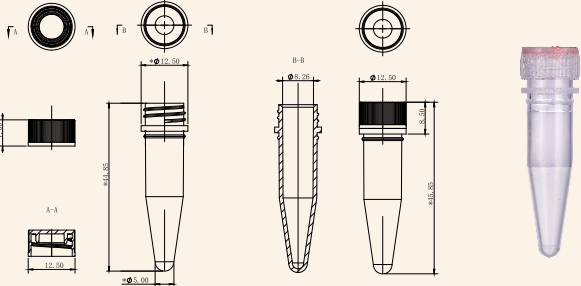
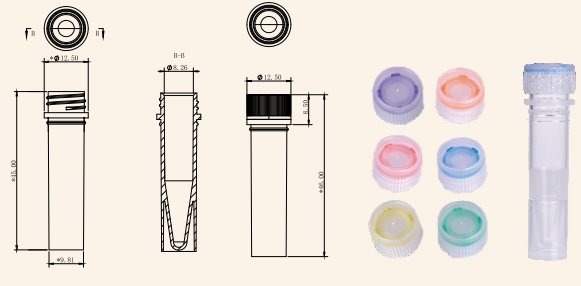
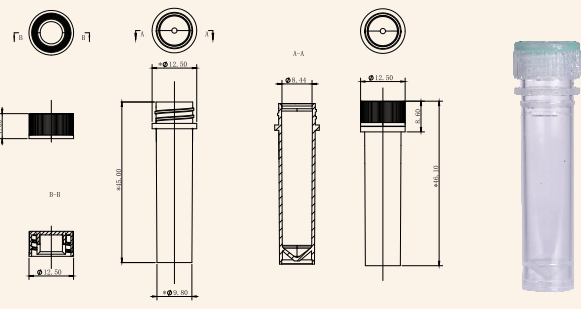
	<b>GEB Cat#</b>	<b>Volume</b>	<b>Description</b>	<b>Color</b>
	SCT060-ST-N	0.6ml	Self-standing	Natural
	SCT060-ST-B	0.6ml	Self-standing	Blue
	SCT060-ST-G	0.6ml	Self-standing	Green
	SCT060-ST-O	0.6ml	Self-standing	Orange
	SCT060-ST-R	0.6ml	Self-standing	Red
	SCT060-ST-V	0.6ml	Self-standing	Violet
	SCT060-ST-A	0.6ml	Self-standing	Amber
	SCT060-ST-Y	0.6ml	Self-standing	Yellow
	SCT150-C-N	1.5ml	V-bottom	Natural
	SCT150-C-B	1.5ml	V-bottom	Blue
	SCT150-C-G	1.5ml	V-bottom	Green
	SCT150-C-O	1.5ml	V-bottom	Orange
	SCT150-C-R	1.5ml	V-bottom	Red
	SCT150-C-V	1.5ml	V-bottom	Violet
	SCT150-C-A	1.5ml	V-bottom	Amber
	SCT150-C-Y	1.5ml	V-bottom	Yellow
	SCT150-ST-N	1.5ml	Self-standing	Natural
	SCT150-ST-B	1.5ml	Self-standing	Blue
	SCT150-ST-G	1.5ml	Self-standing	Green
	SCT150-ST-O	1.5ml	Self-standing	Orange
	SCT150-ST-R	1.5ml	Self-standing	Red
	SCT150-ST-V	1.5ml	Self-standing	Violet
	SCT150-ST-A	1.5ml	Self-standing	Amber
	SCT150-ST-Y	1.5ml	Self-standing	Yellow
	SCT200-ST-N	2.0ml	Self-standing	Natural
	SCT200-ST-B	2.0ml	Self-standing	Blue
	SCT200-ST-G	2.0ml	Self-standing	Green
	SCT200-ST-O	2.0ml	Self-standing	Orange
	SCT200-ST-R	2.0ml	Self-standing	Red
	SCT200-ST-V	2.0ml	Self-standing	Violet
	SCT200-ST-A	2.0ml	Self-standing	Amber
	SCT200-ST-Y	2.0ml	Self-standing	Yellow



# Blue GEB, Your Better Choice

## Screw Cap Tubes With Caps (Looped)



**Packaging Specification:**  
500 tubes per bag, 8 bags per case





**Carton Size(L\*W\*H):**  
690\*235\*330mm

**Weight:**  
15.6kg

	GEB Cat#	Volume	Description	Color
	SCT060-ST-LP-N	0.6ml	Self-standing	Natural
	SCT060-ST-LP-B	0.6ml	Self-standing	Blue
	SCT060-ST-LP-G	0.6ml	Self-standing	Green
	SCT060-ST-LP-O	0.6ml	Self-standing	Orange
	SCT060-ST-LP-R	0.6ml	Self-standing	Red
	SCT060-ST-LP-V	0.6ml	Self-standing	Violet
	SCT060-ST-LP-A	0.6ml	Self-standing	Amber
	SCT150-C-LP-N	1.5ml	V-bottom	Natural
	SCT150-C-LP-B	1.5ml	V-bottom	Blue
	SCT150-C-LP-G	1.5ml	V-bottom	Green
	SCT150-C-LP-O	1.5ml	V-bottom	Orange
	SCT150-C-LP-R	1.5ml	V-bottom	Red
	SCT150-C-LP-V	1.5ml	V-bottom	Violet
	SCT150-C-LP-A	1.5ml	V-bottom	Amber
	SCT150-ST-LP-N	1.5ml	Self-standing	Natural
	SCT150-ST-LP-B	1.5ml	Self-standing	Blue
	SCT150-ST-LP-G	1.5ml	Self-standing	Green
	SCT150-ST-LP-O	1.5ml	Self-standing	Orange
	SCT150-ST-LP-R	1.5ml	Self-standing	Red
	SCT150-ST-LP-V	1.5ml	Self-standing	Violet
	SCT150-ST-LP-A	1.5ml	Self-standing	Amber
	SCT200-ST-LP-N	2.0ml	Self-standing	Natural
	SCT200-ST-LP-B	2.0ml	Self-standing	Blue
	SCT200-ST-LP-G	2.0ml	Self-standing	Green
	SCT200-ST-LP-O	2.0ml	Self-standing	Orange
	SCT200-ST-LP-R	2.0ml	Self-standing	Red
	SCT200-ST-LP-V	2.0ml	Self-standing	Violet
	SCT200-ST-LP-A	2.0ml	Self-standing	Amber
SCT200-ST-LP-Y	2.0ml	Self-standing	Yellow	

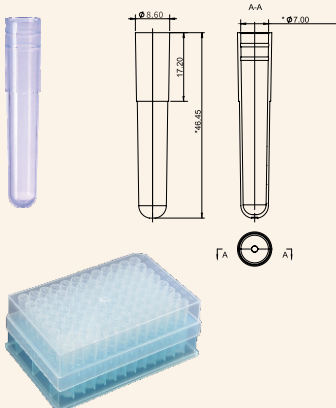
## GEB Sample Tubes

### Individual Sample tubes

	GEB Cat#	Volume	Type	Packaging Specification
	TT1201-2-B-N	1.2 ml	Natural	1000 tubes per bag ,10 bags per case
	 TT1201-2-B-N-LB	1.2 ml	Natural Low Retention	1000 tubes per bag ,10 bags per case
	TT1201-2-9-N	1.2 ml	Natural	96 tubes per rack 10 racks per pack , 5packs per case
	 TT1201-2-9-N-LB	1.2 ml	Natural Low Retention	96 tubes per rack 10 racks per pack , 5packs per case
	TT1201-2-9-NS	1.2 ml	Natural Pre-Sterilized	96 tubes per rack 10 racks per pack , 5packs per case
	 TT1201-2-9-NS-LB	1.2 ml	Natural Low Retention,Pre-Sterilized	96 tubes per rack 10 racks per pack , 5packs per case

### 8 Strip Sample tubes

	GEB Cat#	Volume	Type	Packaging Specification
	TT1208-B-N	1.2 ml	Natural	125 Strips per bag,10 bags per case
	 TT1208-B-N-LB	1.2 ml	Natural Low Retention	125 Strips per bag,10 bags per case
	TT1208-9-N	1.2 ml	Natural	12 Strips per rack 5 packs per case , 10 racks per pack
	 TT1208-9-N-LB	1.2 ml	Natural Low Retention	12 Strips per rack 5 packs per case , 10 racks per pack
	TT1208-9-NS	1.2 ml	Natural Pre-Sterilized	12 Strips per rack 5 packs per case , 10 racks per pack
	 TT1208-9-NS-LB	1.2 ml	Natural Low Retention,Pre-Sterilized	12 Strips per rack 5 packs per case , 10 racks per pack

### Seal Mats for Sample tubes (TT1201 & TT1208)

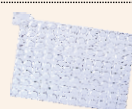
	GEB Cat#	Type	Packaging	Packaging Specification
	TTOMAT-08-N	Natural	Bulk	125 Strips per bag , 5 bags per case
	TTOMAT-9-N	Natural	Bulk	10 mats per bag , 5 bags per case

# Blue GEB, Your Better Choice

## Silicone Sealing Mats Separable Sealing Mats

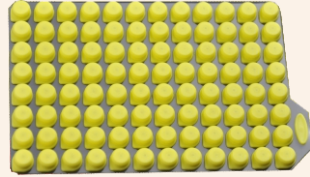

### For 1.3ml Round deep well plate & GEB sample tube

	GEB Cat#	Color	Packaging Specification	Carton Size L*W*H(mm)	Weight KGs
	CSMATR-9-R	Red	10 mats per bag, 5 bags per case	465*155*135	1.18
	CSMATR-9-Y	Yellow	10 mats per bag, 5 bags per case	465*155*135	1.18
	CSMATR-9-O	Orange	10 mats per bag, 5 bags per case	465*155*135	1.18
	CSMATR-9-G	Green	10 mats per bag, 5 bags per case	465*155*135	1.18
	CSMATR-9-B	Blue	10 mats per bag, 5 bags per case	465*155*135	1.18
	CSMATR-9-V	Violet	10 mats per bag, 5 bags per case	465*155*135	1.18

# Sponge Swab

FOR ORAL FLUID AND CELL COLLECTION SYSTEM

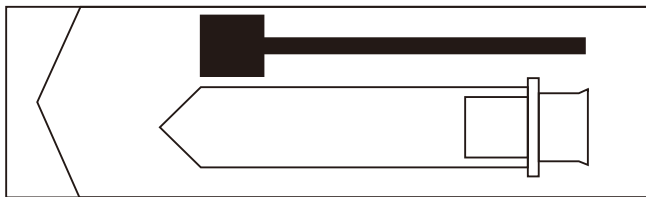
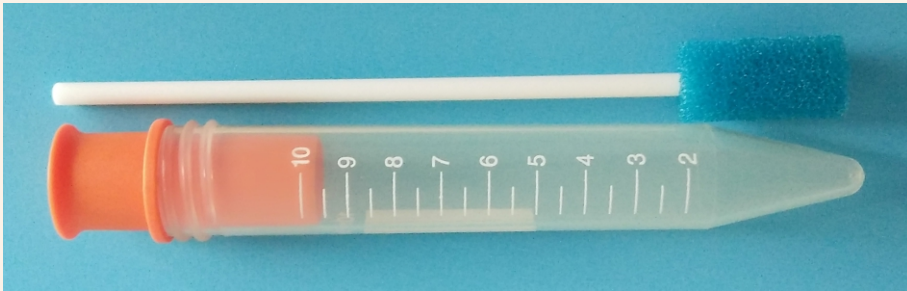

This sponge swab is designed to collect oral fluid and cells. The swab is used like a toothbrush. Firstly open the package and remove the tube.



Oral fluid or cells are collected by rubbing the sponge firmly along the gum (at the base of the teeth if present) until the sponge swab is wet. It takes about one minute.



Replace the swab in the tube and close the cap. Return sample to the laboratory for processing

This product can do not need to use the centrifuge and can recycle oral liquid and cells, operation is as follows



Place the swab upside down in the tube

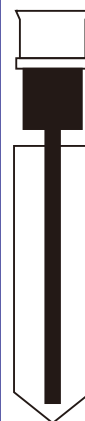

Close the cap, the cap can squeeze liquid

Liquid recovery can be achieved >93%

# Reservoirs

## Optimum sample collection and storage

GEB exclusive R&R Low Retention technique provides Reservoirs with the optimum sample and reagent saving effect

High Throughput Screening(HTS)•Samples & reagents storage

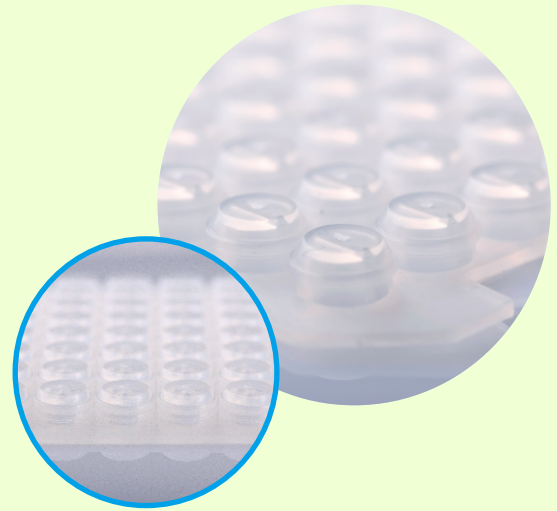

### O-ring

Special designing of O ring which optimizes leakproofness and makes closing and opening more easily.



### GEB R&R Low Retention Technique

GEB's **R&R** liquid reservoirs provide you a maximum saving effect for biological solutions including samples and reagents to guarantee accurate and repeatable results.

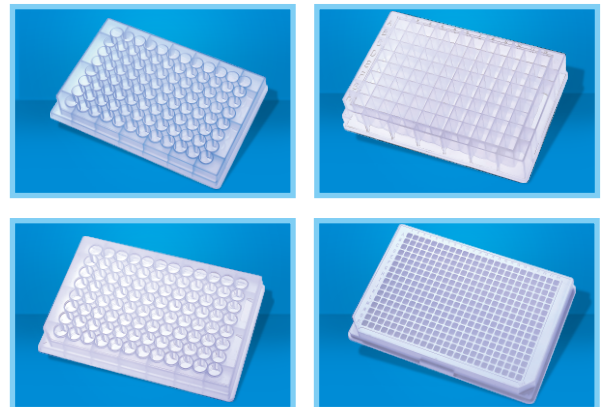

#### Features:

- Polypropylene can be autoclavable at 121°C and it is also long-term stable at -80°C.
- U-shaped and V-shaped bottom outlet series most suitable for mixing and collection of samples.
- Alphabetical sorting and cut angle mark for convenient tracking of samples.
- Applicable to multi-channel pipettors and automation systems.



# Blue GEB, Your Better Choice

## Deep Well Plates 96 Round Well Series



**330µl Deep-well plate, Round well-V bottom**  
Made of virgin polypropylene



**Packaging Specification:**  
10 plates per bag, 10 bags per case

**Carton Size(L\*W\*H):**  
440\*275\*150mm

**Weight:**  
5.0kg

GEB Cat#	Working Volume	Type	Color
DP33VR-9-N	330µl		Natural
DP33VR-9-N-LB	330µl	Low Retention	Natural
DP33VR-9-NS	330µl	Pre-Sterilized	Natural
DP33VR-9-NS-LB	330µl	Low Retention,Pre-Sterilized	Natural
DP33VR-9-B	330µl		Blue
DP33VR-9-B-LB	330µl	Low Retention	Blue
DP33VR-9-BS	330µl	Pre-Sterilized	Blue
DP33VR-9-BS-LB	330µl	Low Retention,Pre-Sterilized	Blue
DP33VR-9-R	330µl		Red
DP33VR-9-R-LB	330µl	Low Retention	Red
DP33VR-9-RS	330µl	Pre-Sterilized	Red
DP33VR-9-RS-LB	330µl	Low Retention,Pre-Sterilized	Red

**350µl Deep-well plate, Round well-U bottom**  
Made of virgin polypropylene



**Packaging Specification:**  
10 plates per bag, 10 bags per case

**Carton Size(L\*W\*H):**  
440\*275\*150mm

**Weight:**  
5.0kg

GEB Cat#	Working Volume	Type	Color
DP35UR-9-N	350µl		Natural
DP35UR-9-N-LB	350µl	Low Retention	Natural
DP35UR-9-NS	350µl	Pre-Sterilized	Natural
DP35UR-9-NS-LB	350µl	Low Retention,Pre-Sterilized	Natural
DP35UR-9-B	350µl		Blue
DP35UR-9-B-LB	350µl	Low Retention	Blue
DP35UR-9-BS	350µl	Pre-Sterilized	Blue
DP35UR-9-BS-LB	350µl	Low Retention,Pre-Sterilized	Blue
DP35UR-9-R	350µl		Red
DP35UR-9-R-LB	350µl	Low Retention	Red
DP35UR-9-RS	350µl	Pre-Sterilized	Red
DP35UR-9-RS-LB	350µl	Low Retention,Pre-Sterilized	Red

## Deep Well Plates

### 96 Round Well Series

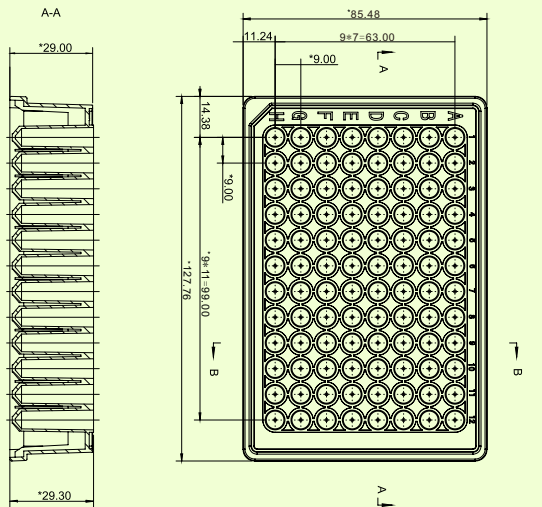

**0.8ml**

DP08VR-9I-N

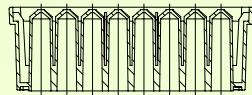

B-B

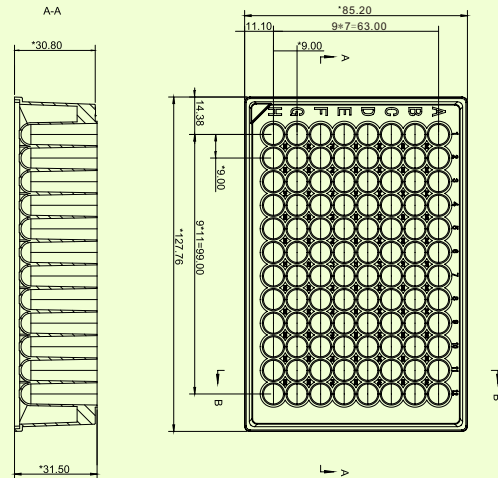

**1.2ml**

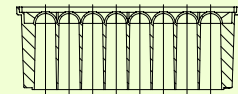

DP12UR-9-N



B-B



### 0.8ml Deep-well plate, Round well-V bottom

Made of virgin polypropylene

	GEB Cat#	Volume	Type	Packaging Specification	Carton Size L*W*H(mm)	Weight KGs
	DP08VR-9I-N	0.8ml	Natural	5 plates per bag, 10 bags per case	450*270*190	4.4
	 DP08VR-9I-N-LB	0.8ml	Natural Low Retention	5 plates per bag, 10 bags per case	450*270*190	4.4
	DP08VR-9I-NS	0.8ml	Natural Pre-Sterilized	5 plates per bag, 10 bags per case	450*270*190	4.4
	 DP08VR-9I-NS-LB	0.8ml	Natural Low Retention, Pre-Sterilized	5 plates per bag, 10 bags per case	450*270*190	4.4

### 1.2ml Deep-well plate, Round well-U bottom

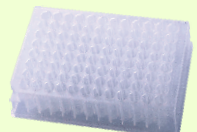
Made of virgin polypropylene

	GEB Cat#	Volume	Type	Packaging Specification	Carton Size L*W*H(mm)	Weight KGs
	DP12UR-9-N	1.2ml	Natural	5 plates per bag, 10 bags per case	450*270*190	4.5
	 DP12UR-9-N-LB	1.2ml	Natural Low Retention	5 plates per bag, 10 bags per case	450*270*190	4.5
	DP12UR-9-NS	1.2ml	Natural Pre-Sterilized	5 plates per bag, 10 bags per case	450*270*190	4.5
	 DP12UR-9-NS-LB	1.2ml	Natural Low Retention, Pre-Sterilized	5 plates per bag, 10 bags per case	450*270*190	4.5

# Blue GEB, Your Better Choice

## Deep Well Plates 96 Round Well Series

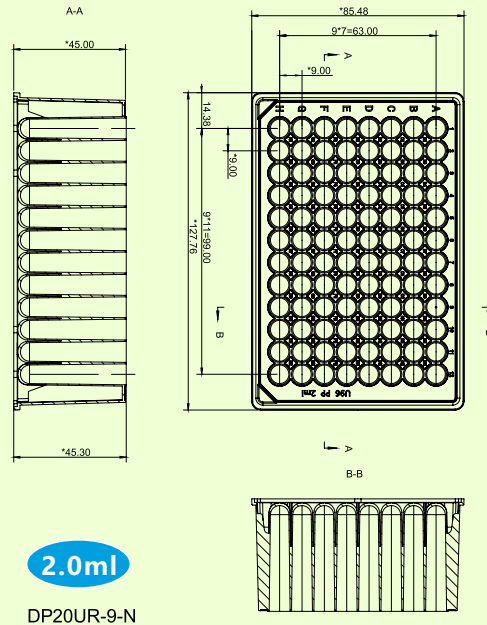
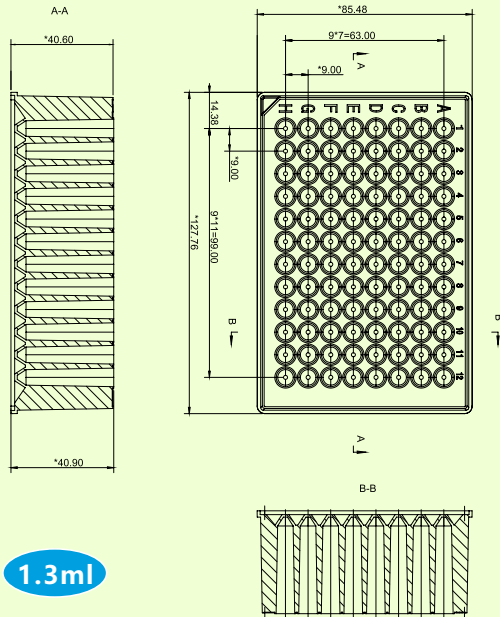

### 1.3ml Deep-well plate, Round well-U bottom

Made of virgin polypropylene

	GEB Cat#	Volume	Type	Packaging Specification	Carton Size L*W*H(mm)	Weight KGs
	DPI3UR-9I-N	1.3ml	Natural	5 plates per bag, 10 bags per case	440*270*240	6.7
	DPI3UR-9I-N-LB	1.3ml	Natural Low Retention	5 plates per bag, 10 bags per case	440*270*240	6.7
	DPI3UR-9I-NS	1.3ml	Natural Pre-Sterilized	5 plates per bag, 10 bags per case	440*270*240	6.7
	DPI3UR-9I-NS-LB	1.3ml	Natural Low Retention, Pre-Sterilized	5 plates per bag, 10 bags per case	440*270*240	6.7

### 2.0ml Deep-well plate, Round well-U bottom

Made of virgin polypropylene

	GEB Cat#	Volume	Type	Packaging Specification	Carton Size L*W*H(mm)	Weight KGs
	DP20UR-9-N	2.0ml	Natural	5 plates per bag, 10 bags per case	440*270*240	6.8
	DP20UR-9-N-LB	2.0ml	Natural Low Retention	5 plates per bag, 10 bags per case	440*270*240	6.8
	DP20UR-9-NS	2.0ml	Natural Pre-Sterilized	5 plates per bag, 10 bags per case	440*270*240	6.8
	DP20UR-9-NS-LB	2.0ml	Natural Low Retention, Pre-Sterilized	5 plates per bag, 10 bags per case	440*270*240	6.8



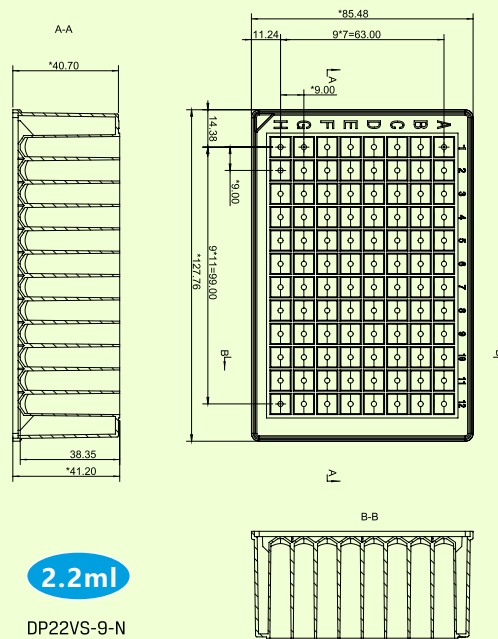
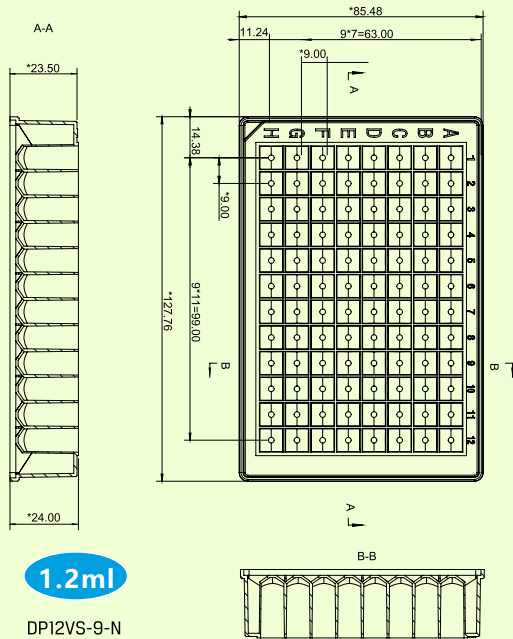

## Deep Well Plates

### 96 Square Well Series



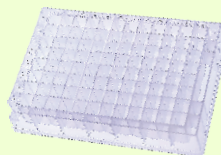

### 1.2ml Deep-well plate, square well-V bottom

Made of virgin polypropylene

	GEB Cat#	Volume	Type	Packaging Specification	Carton Size L*W*H(mm)	Weight KGs
	DPI2VS-9-N	1.2ml	Natural	10 plates per bag, 10 bags per case	440*270*240	7.2
	 DPI2VS-9-N-LB	1.2ml	Natural Low Retention	10 plates per bag, 10 bags per case	440*270*240	7.2
	DPI2VS-9-NS	1.2ml	Natural Pre-Sterilized	10 plates per bag, 10 bags per case	440*270*240	7.2
	 DPI2VS-9-NS-LB	1.2ml	Natural Low Retention, Pre-Sterilized	10 plates per bag, 10 bags per case	440*270*240	7.2

### 2.2ml Deep-well plate, square well-V bottom

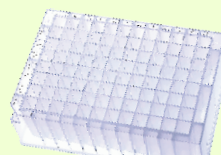
Made of virgin polypropylene

	GEB Cat#	Volume	Type	Packaging Specification	Carton Size L*W*H(mm)	Weight KGs
	DP22VS-9-N	2.2ml	Natural	5 plates per bag, 10 bags per case	440*270*240	7.5
	 DP22VS-9-N-LB	2.2ml	Natural Low Retention	5 plates per bag, 10 bags per case	440*270*240	7.5
	DP22VS-9-NS	2.2ml	Natural Pre-Sterilized	5 plates per bag, 10 bags per case	440*270*240	7.5
	 DP22VS-9-NS-LB	2.2ml	Natural Low Retention, Pre-Sterilized	5 plates per bag, 10 bags per case	440*270*240	7.5

# Blue GEB, Your Better Choice

## Deep Well Plates 96 Square Well Series

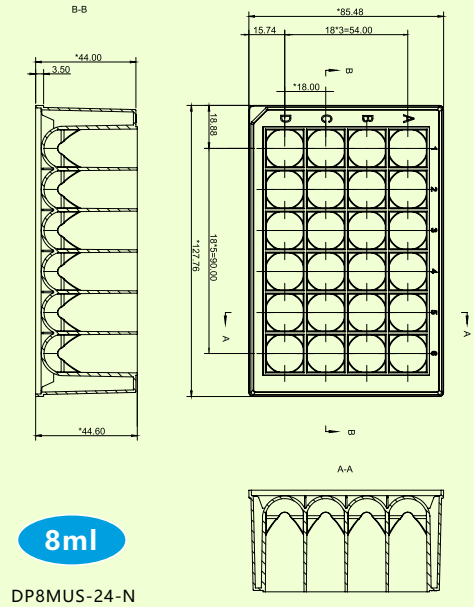
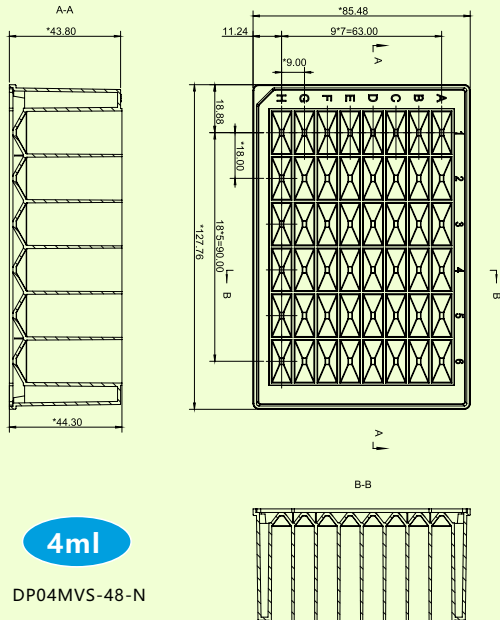

### 4ml 48-well plate, square well-V bottom

Made of virgin polypropylene



GEB Cat#	Volume	Type	Packaging Specification	Carton Size L*W*H(mm)	Weight KGs
DP4MVS-48-N	4ml	Natural	5 plates per bag, 10 bags per case	440*270*240	9.04
 DP4MVS-48-NS	4ml	Natural Pre-Sterilized	5 plates per bag, 10 bags per case	440*270*240	9.04

### 8ml 24-well plate, square well-U bottom

Made of virgin polypropylene



GEB Cat#	Volume	Type	Packaging Specification	Carton Size L*W*H(mm)	Weight KGs
DP8MUS-24-N	8ml	Natural	5 plates per bag, 10 bags per case	440*270*240	9.04
 DP8MUS-24-NS	8ml	Natural Pre-Sterilized	5 plates per bag, 10 bags per case	440*270*240	9.04

### Sealing mat fit 96 Square well series

Made of virgin Thermoplastic polypropylene

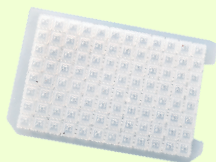

GEB Cat#	Type	Description	Packaging Specification	Carton Size L*W*H(mm)	Weight KGs
DPMS-9-W+	Natural	"+" Hole	10 mats per bag, 5 bags per case	465*155*135	1.80
DPMS-9-WS+	Natural, Pre-Sterilized	"+" Hole	10 mats per bag, 5 bags per case	465*155*135	1.80
DPMS-9-IMP-W+	Natural, Chemically Resistant	"+" Hole	10 mats per bag, 5 bags per case	465*155*135	1.80
DPMS-9-IMP-WS+	Natural, Pre-Sterilized Chemically Resistant	"+" Hole	10 mats per bag, 5 bags per case	465*155*135	1.80





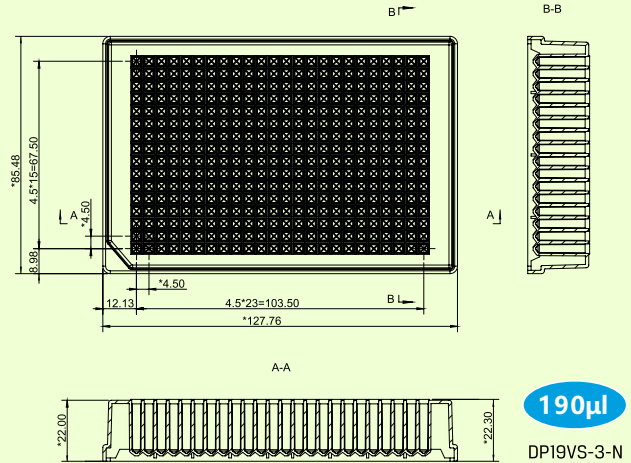
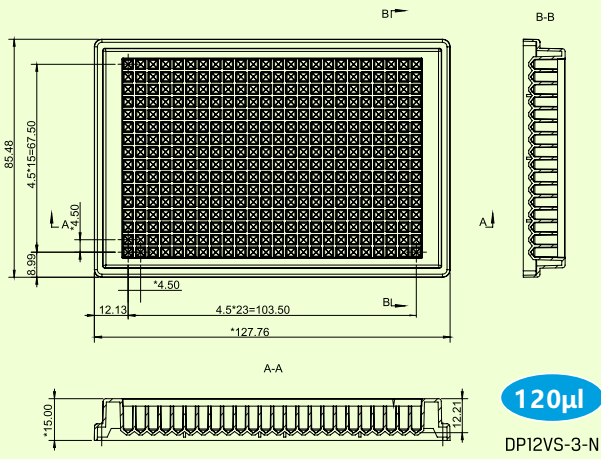

## Deep Well Plates

### 384 Square Well Series



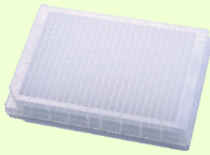



#### 120µl Deep-well plate, square well-V bottom

Made of virgin polypropylene

GEB Cat#	Volume	Type	Packaging Specification	Carton Size L*W*H(mm)	Weight KGs
 DPI2VS-3-N	120µl	Natural	10 plates per bag, 10 bags per case	450*270*190	4.8
 DPI2VS-3-N-LB	120µl	Natural Low Retention	10 plates per bag, 10 bags per case	450*270*190	4.8
 DPI2VS-3-NS	120µl	Natural Pre-Sterilized	10 plates per bag, 10 bags per case	450*270*190	4.8
 DPI2VS-3-NS-LB	120µl	Natural Low Retention,Pre-Sterilized	10 plates per bag, 10 bags per case	450*270*190	4.8

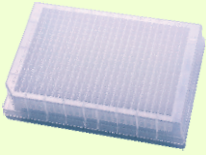
#### 190µl Deep-well plate, square well-V bottom

Made of virgin polypropylene

GEB Cat#	Volume	Type	Packaging Specification	Carton Size L*W*H(mm)	Weight KGs
 DPI9VS-3-N	190µl	Natural	10 plates per bag, 10 bags per case	440*270*240	4.8
 DPI9VS-3-N-LB	190µl	Natural Low Retention	10 plates per bag, 10 bags per case	440*270*240	4.8
 DPI9VS-3-NS	190µl	Natural Pre-Sterilized	10 plates per bag, 10 bags per case	440*270*240	4.8
 DPI9VS-3-NS-LB	190µl	Natural Low Retention,Pre-Sterilized	10 plates per bag, 10 bags per case	440*270*240	4.8

#### Sealing mat fit 384 Square well plate series

Made of virgin Thermoplastic polyurethane

GEB Cat#	Type	Description	Packaging Specification	Carton Size L*W*H(mm)	Weight KGs
 DPMS-3-W+	Natural	"+" Hole	10 mats per bag, 5 bags per case	465*155*135	1.43
DPMS-3-WS+	Natural,Pre-Sterilized	"+" Hole	10 mats per bag, 5 bags per case	465*155*135	1.43
DPMS-3-IMP-W+	Natural,Chemically Resistant	"+" Hole	10 mats per bag, 5 bags per case	465*155*135	1.43
DPMS-3-IMP-WS+	Natural, Pre-Sterilized Chemically Resistant	"+" Hole	10 mats per bag, 5 bags per case	465*155*135	1.43

You may also be interested in:

#### Lid fit 96/384 Deep-well plate

Packaging Specification:  
10 plates per bag, 10 bags per case



GEB Cat#	Type	Color	Product Description	Packaging
DPOLID-3-N		Natural	fit 96/384 Deep	Bulk
DPOLID-3-NS	Pre-Sterilized	Natural	fit 96/384 Deep	Bulk

# Sealing Mats

## Optimum Leakproofness

Drug discovery • Molecular biology • Cell biology

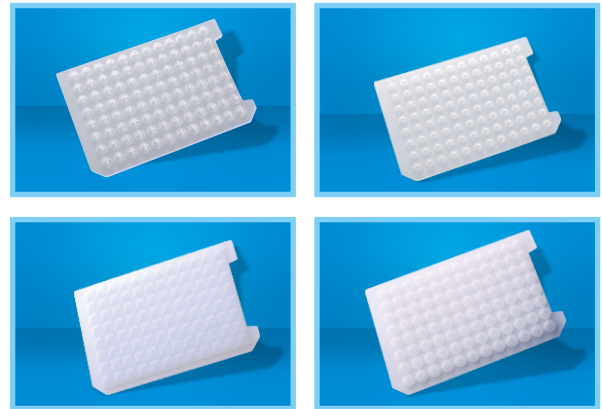

### Exclusive Designed O ring

GEB Seal Mats for Deep Well Plates & Sample Tubes have an exclusive O ring structure, which makes GEB Seal Mat seal a plate more easily with a perfect sealing effect.

#### Features:

- The most complete line of sealing products in the industry, for the most choices.
- EasyPress and MiniSealer offer easier-operating and time-consuming options.
- A wide range of ImpermaMats offer unsurpassed protection for Volatile solvents.
- Films and mats can be used in a wide temperature range, they are suitable for most applications.
- Chemically resistant, pierceable thermoplastic elastomer well caps are excellent for storage to -80°C.
- Silicone pre-slit well caps permit a pipette tip or probe to enter the well without damage to the cap.
- Ethylene-vinyl acetate cap mats effectively seal polystyrene DeepWell™ plates.



## Silicone Sealing Mats Sealing Mats

### For Sample tubes

#### Sealing Mat fits GEB Sample tubes

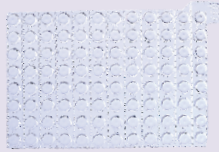

GEB Cat#	Color	Type	Description	Packaging Specification
TTOMAT-9-N	Natural	Common	Non-Sterilized	10 mats per bag, 5 bags per case

### For PCR microplates

#### 96 well PCR Sealing Mats



#### Packaging Specification:

Carton Size:465\*155\*135mm Weight:1.54kg

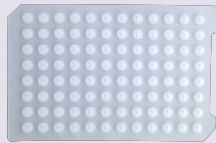

GEB Cat#	Color	Type	Description	Packaging Specification
PCOMAT-9-W-	white	Common	"+" Hole, fits 96 PCR Plate, $\Phi=5.6$	10 mats per bag, 5 bags per case
PCOMAT-9-WS-	white	Pre-Sterilized	"+" Hole, fits 96 PCR Plate, $\Phi=5.6$	10 mats per bag, 5 bags per case
PCOMAT-9-IMP-W-	white	Chemically Resistant	"+" Hole, fits 96 PCR Plate, $\Phi=5.6$	10 mats per bag, 5 bags per case
PCOMAT-9-IMP-WS-	white	Pre-Sterilized Chemically Resistant	"+" Hole, fits 96 PCR Plate, $\Phi=5.6$	10 mats per bag, 5 bags per case

### Compatible Sealing Mats

#### 384 well PCR Sealing Mats



#### Packaging Specification:

Carton Size:465\*155\*135mm Weight:1.43kg



GEB Cat#	Color	Type	Description	Packaging Specification
DPMR-3-W+	Natural	Common	"+" Hole, fits 384PCR Plate	10 mats per bag, 5 bags per case
DPMR-3-WS+	Natural	Pre-Sterilized	"+" Hole, fits 384PCR Plate	10 mats per bag, 5 bags per case
DPMR-3-IMP-W+	Natural	Chemically Resistant	"+" Hole, fits 384PCR Plate	10 mats per bag, 5 bags per case
DPMR-3-IMP-WS+	Natural	Pre-Sterilized Chemically Resistant	"+" Hole, fits 384PCR Plate	10 mats per bag, 5 bags per case

### 96-well Sealing Mats for Round Well



#### Packaging Specification:

Carton Size:465\*155\*135mm Weight:1.80kg



GEB Cat#	Color	Type	Description	Packaging Specification
DPMR-9-W-	Natural	Common	"+" Hole, $\Phi=7.3$	10 mats per bag, 5 bags per case
DPMR-9-WS-	Natural	Pre-Sterilized	"+" Hole, $\Phi=7.3$	10 mats per bag, 5 bags per case
DPMR-9-IMP-W-	Natural	Chemically Resistant	"+" Hole, $\Phi=7.3$	10 mats per bag, 5 bags per case
DPMR-9-IMP-WS-	Natural	Pre-Sterilized Chemically Resistant	"+" Hole, $\Phi=7.3$	10 mats per bag, 5 bags per case

Fit DP13UR-9I-N/ Fit DP08VR-9I-N

# Blue GEB, Your Better Choice

## Silicone Sealing Mats Sealing Mats



### 96-well Sealing Mats for Round Well plates



**Packaging Specification:**

Carton Size:465\*155\*135mm Weight:1.80kg

GEB Cat#	Color	Type	Description	Packaging Specification
DPMR-9-W+	Natural	Common	"+" Hole, Φ=8.3	10 mats per bag, 5 bags per case
DPMR-9-WS+	Natural	Pre-Sterilized	"+" Hole, Φ=8.3	10 mats per bag, 5 bags per case
DPMR-9-IMP-W+	Natural	Chemically Resistant	"+" Hole, Φ=8.3	10 mats per bag, 5 bags per case
DPMR-9-IMP-WS+	Natural	Pre-Sterilized Chemically Resistant	"+" Hole, Φ=8.3	10 mats per bag, 5 bags per case

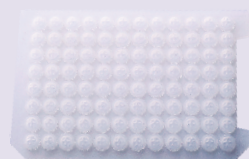

Fit DP12UR-9-N/DP20UR-9-N

### 96-well Sealing Mats for Square Well plates



**Packaging Specification:**

Carton Size:465\*155\*135mm Weight:1.80kg

GEB Cat#	Color	Type	Description	Packaging Specification
DPMS-9-W+	Natural	Common	"+" Hole	10 mats per bag, 5 bags per case
DPMS-9-WS+	Natural	Pre-Sterilized	"+" Hole	10 mats per bag, 5 bags per case
DPMS-9-IMP-W+	Natural	Chemically Resistant	"+" Hole	10 mats per bag, 5 bags per case
DPMS-9-IMP-WS+	Natural	Pre-Sterilized Chemically Resistant	"+" Hole	10 mats per bag, 5 bags per case



Fit DP12VS-9-N/DP22VS-9-N

### 384-well Reservoirs Sealing Mats for Square Well plates



**Packaging Specification:**

Carton Size:465\*155\*135mm Weight:1.80kg

GEB Cat#	Color	Type	Description	Packaging Specification
DPMS-3-W+	Natural	Common	"+" Hole, Φ=7.3	10 mats per bag, 5 bags per case
DPMS-3-WS+	Natural	Pre-Sterilized	"+" Hole, Φ=7.3	10 mats per bag, 5 bags per case
DPMS-3-IMP-W+	Natural	Chemically Resistant	"+" Hole, Φ=7.3	10 mats per bag, 5 bags per case
DPMS-3-IMP-WS+	Natural	Pre-Sterilized Chemically Resistant	"+" Hole, Φ=7.3	10 mats per bag, 5 bags per case



Fit DP12VS-3-N/DP19VS-3-N